



# Access Control Products Catalogue

June 2012

FSM Manufacturing Ltd  
Sturmer Road  
Haverhill  
Suffolk  
CB9 7UU

Telephone: 01440 762561  
Fax: 01440 706251

Email: [sales@fsm.co.uk](mailto:sales@fsm.co.uk)  
Website: [www.fsm.co.uk](http://www.fsm.co.uk)

Push to Exit & Fireman Switches



Camera Housings for Lobbies, Lifts & Corners

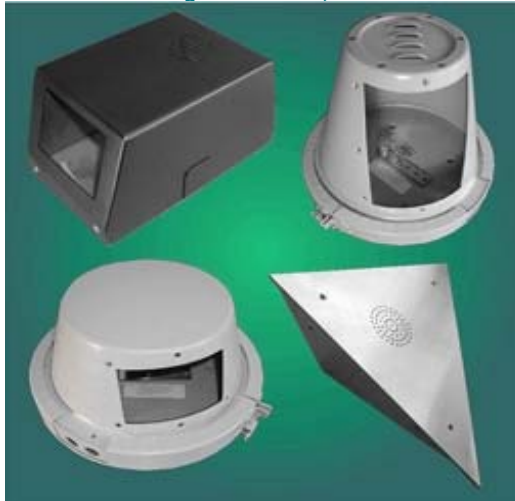

Door Entry Panels



DDA Panels (Disability Discrimination Act)



Steel Door Systems (details on request)



Access Control Posts



# Contents

<b>Illustration of Panel Format</b> .....	<b>1</b>
<b>Pedestrian Access Control</b> (PAC Reader / Push to Exit Housings) .....	<b>2</b>
<b>DDA Push to Exit Panels</b> (pushbuttons & braille) .....	<b>3</b>
<b>Emergency Access Control</b> (Emergency Services / Fire Control Switch Housings) .....	<b>4</b>
<b>Ancillary Items</b> (Fireman's Switch keys, Vandal Resistant Screws & Screwdrivers) .....	<b>5</b>
<b>Surveillance</b> (Camera Housings / Brackets) .....	<b>6</b>
<b>Access Control Posts</b> .....	<b>7</b>
<b>Door Accessories</b> (Handles / Push Plates / Kick Plates / Lock Protection Plates / Downlighters) .....	<b>8</b>
<b>Type 2 Door Entry Panels</b> .....	<b>9</b>
<b>Type 3 Door Entry Panels</b> .....	<b>10</b>
<b>Type 4 Door Entry Panels</b> .....	<b>11</b>
<b>Type 5 Door Entry Panels</b> .....	<b>12</b>
<b>Type 6 Door Entry Panels</b> .....	<b>13-14</b>
<b>Panel Specification</b> .....	<b>15</b>

## Conditions of Sale

We reserve the right to amend any errors or omissions.

All goods will be packaged to ensure safe carriage, and the company will not accept responsibility for loss or damage in transit. Any such claims must be reported to FSM within 3 working days of delivery.

We reserve the right to alter the specification without prior notice without incurring any liability. All information and data given in company literature is subject to variation and is for general information only.

FSM will not normally accept goods for re-stocking, however, where exceptions are made, a handling charge of 20% of original invoice value will be applied.

Carriage will be added - subject to weight / delivery method.

All orders are accepted subject to our 'Terms & Conditions of Sale', a copy of which is available on request.



## ILLUSTRATION OF PANEL FORMAT



Fascia Only ( /F)

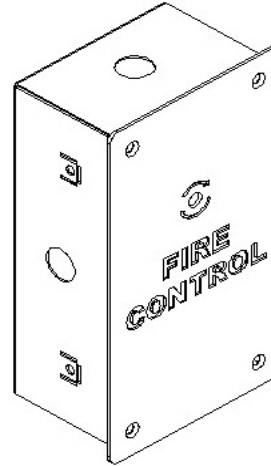

Flush Housing with Overlap Fascia ( /OL)

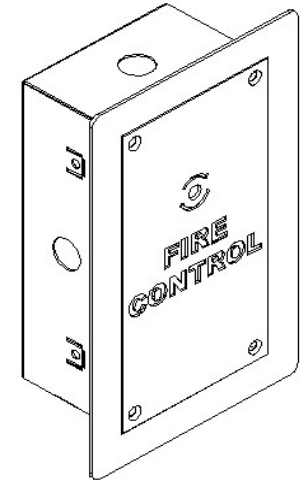

Flush Housing with Mitred Bezel ( /MB)

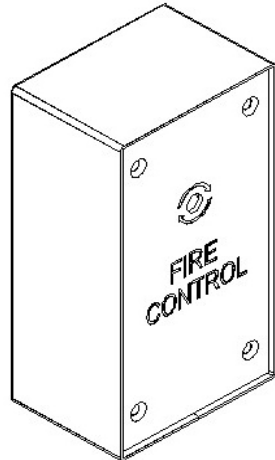

Surface Mounted Housing ( /SM)



Surface Mounted Housing with Rainhood ( /RH)

**PEDESTRIAN ACCESS CONTROL**

**CODE**



**PROXIMITY READER HOUSING**

Surface Mounted  
 Surface Mounted (with Rainhood)  
 Flush with MB surround & back box (108mm x 108mm x 65mm)  
 Fascia Only

**PRH/SM  
 PRH/RH  
 PRH/MB  
 PRH/F**



**1 WAY PUSH TO EXIT HOUSING**

Surface Mounted  
 Surface Mounted (with Rainhood)  
 Flush with MB surround & back box (108mm x 108mm x 65mm)  
 Fascia Only

**PTE1/SM  
 PTE1/RH  
 PTE1/MB  
 PTE1/F**



**2 WAY PUSH TO EXIT HOUSING**

Surface Mounted  
 Surface Mounted (with Rainhood)  
 Flush with MB surround & back box (108mm x 108mm x 65mm)  
 Fascia Only

**PTE2/SM  
 PTE2/RH  
 PTE2/MB  
 PTE2/F**



**1 WAY SLIMLINE PUSH TO EXIT HOUSING**

Surface Mounted  
 Surface Mounted (with Rainhood)  
 Flush with MB surround & back box (115mm x 50mm x 35mm)  
 Fascia Only

**SPTE1/SM  
 SPTE1/RH  
 SPTE1/MB  
 SPTE1/F**



**2 WAY SLIMLINE PUSH TO EXIT HOUSING**

Surface Mounted  
 Surface Mounted (with Rainhood)  
 Flush with MB surround & back box (115mm x 50mm x 35mm)  
 Fascia Only

**SPTE2/SM  
 SPTE2/RH  
 SPTE2/MB  
 SPTE2/F**

1. SM = Surface Mounted. RH = Rainhood. MB = Mitred Bezel. F = Fascia. (See Page 1 for Illustrations)  
 2. M5 V/R machine screws are included in all door release switches except fascia panels which are supplied with No.10 V/R woodscrews. Screwdrivers are at an additional cost and are not supplied unless specified (see Page 5).  
 3. All MK6/2 pushbuttons and engraving works have been included where applicable.  
 4. All prices are ex.works. Carriage will be subject to weight / delivery method.



**DDA PUSH TO EXIT PANELS**



**1 WAY PUSH TO EXIT HOUSING (Incl DDA pushbutton & Braille)**

- Surface Mounted
- Surface Mounted (with Rainhood)
- Flush with MB surround & back box (108mm x 108mm x 65mm)
- Fascia Only

- PTE1Y/SM/BRAILLE
- PTE1Y/RH/BRAILLE
- PTE1Y/MB/BRAILLE
- PTE1Y/F/BRAILLE

**2 WAY PUSH TO EXIT HOUSING (Incl DDA pushbutton & Braille)**

- Surface Mounted
- Surface Mounted (with Rainhood)
- Flush with MB surround & back box (108mm x 108mm x 65mm)
- Fascia Only

- PTE2Y/SM/BRAILLE
- PTE2Y/RH/BRAILLE
- PTE2Y/MB/BRAILLE
- PTE2Y/F/BRAILLE



**1 WAY SLIMLINE PUSH TO EXIT HOUSING (Incl DDA Pushbutton & Braille)**

- Surface Mounted
- Surface Mounted (with Rainhood)
- Flush with MB surround & back box (115mm x 50mm x 35mm)
- Fascia Only

- SPTE1Y/SM/BRAILLE
- SPTE1Y/RH/BRAILLE
- SPTE1Y/MB/BRAILLE
- SPTE1Y/F/BRAILLE

**2 WAY PUSH TO EXIT HOUSING (Incl DDA pushbutton & Braille)**

- Surface Mounted
- Surface Mounted (with Rainhood)
- Flush with MB surround & back box (108mm x 108mm x 65mm)
- Fascia Only

- SPTE2Y/SM/BRAILLE
- SPTE2Y/RH/BRAILLE
- SPTE2Y/MB/BRAILLE
- SPTE2Y/F/BRAILLE



**PUSHBUTTONS**

- MK5 Pushbutton (Mechanical) excluding yellow extended tactile collar
- MK6/1 Pushbutton (Single Switched) excluding yellow extended tactile collar
- MK6/2 Pushbutton (Double Switched) excluding yellow extended tactile collar
- Yellow extended tactile collar to suit all above (excluding pushbutton)

- MK5
- MK6/1
- MK6/2
- /Y



**BRAILLE**

Braille (per Character)

**BRAILLE**

**All panels can be manufactured to comply with your Disability Discrimination Act requirements**







(please contact us for further information)

**NOTES:**

1. Pushbuttons are supplied in packs of 10.
2. M5 V/R machine screws are included within the above Push to Exit panels (fascias are supplied with No.10 V/R woodscrews). Screwdrivers are at an additional cost.
3. MK6/2/Y DDA pushbuttons together with all engraving and braille works have been included within the Push to Exit panels as indicated.
4. In some instances the size of the standard panel may need to be increased in order to accommodate the braille (please contact us for assistance if unsure)
5. Please insert a 'Y' after the button part number in order to depict that a yellow collar is required and allow for the cost of the collars on top of the button price.
6. Please allow an additional braille character for all number sequences to allow for the braille number symbol prefix ie. 123 = 4 characters.



<b>EMERGENCY ACCESS CONTROL</b>		<u><b>CODE</b></u>
	<p><b>SQUARE EMERGENCY SERVICES SWITCH HOUSING</b>                      (To suit a KY3 Crescent Key. Keys sold separately - see Page 5)</p> <p>Surface Mounted                      Surface Mounted (with Rainhood)                      Flush with MB surround &amp; back box (108mm x 108mm x 65mm)                      Fascia Only</p>	<p><b>FS3S/SM</b>  <b>FS3S/RH</b>  <b>FS3S/MB</b>  <b>FS3S/F</b></p>
	<p><b>FIRE CONTROL SWITCH HOUSING</b>                      (To suit a KY4 Drop Key. Keys sold separately - see Page 5)</p> <p>Surface Mounted                      Surface Mounted (with Rainhood)                      Flush with MB surround &amp; back box (179mm x 95mm x 65mm)                      Fascia Only</p>	<p><b>FS4/SM</b>  <b>FS4/RH</b>  <b>FS4/MB</b>  <b>FS4/F</b></p>
	<p><b>SQUARE FIRE CONTROL SWITCH HOUSING</b>                      (To suit a KY4 Drop Key. Keys sold separately - see Page 5)</p> <p>Surface Mounted                      Surface Mounted (with Rainhood)                      Flush with MB surround &amp; back box (108mm x 108mm x 65mm)                      Fascia Only</p>	<p><b>FS4S/SM</b>  <b>FS4S/RH</b>  <b>FS4S/MB</b>  <b>FS4S/F</b></p>
	<p><b>EMERGENCY SERVICES SWITCH HOUSING</b>                      (To suit a KY5 Drop Key. Keys sold separately - see Page 5)</p> <p>Surface Mounted                      Surface Mounted (with Rainhood)                      Flush with MB surround &amp; back box (179mm x 95mm x 65mm)                      Fascia Only</p>	<p><b>FS5/SM</b>  <b>FS5/RH</b>  <b>FS5/MB</b>  <b>FS5/F</b></p>
	<p><b>SQUARE EMERGENCY SERVICES SWITCH HOUSING</b>                      (To suit a KY5 Drop Key. Keys sold separately - see Page 5)</p> <p>Surface Mounted                      Surface Mounted (with Rainhood)                      Flush with MB surround &amp; back box (108mm x 108mm x 65mm)                      Fascia Only</p>	<p><b>FS5S/SM</b>  <b>FS5S/RH</b>  <b>FS5S/MB</b>  <b>FS5S/F</b></p>
<p><b>NOTES:</b></p> <p>1. SM = Surface Mounted. RH = Rainhood. MB = Mitred Bezel. F = Fascia. (See Page 1 for Illustrations)</p> <p>2. M5 V/R machine screws are included in all door release switches except fascia panels which are supplied with No.10 V/R woodscrews. Screwdrivers are at an additional cost and are not supplied unless specified (see Page 5).</p> <p>3. All engraving works have been included where applicable.</p> <p>4. All prices are ex.works. Carriage will be subject to weight / delivery method.</p>		

<b>ANCILLARY ITEMS</b>		<u>CODE</u>
 <p style="text-align: center;">KY3                      KY4                      KY5</p>	<p><b>FIREMAN'S SWITCH KEYS</b>            CRESCENT KEY (to suit FS3 Fireswitch)            DROP KEY (to suit FS4 Fireswitch)            DROP KEY (to suit FS5 Fireswitch)</p>	<p><b>KY3</b>  <b>KY4</b>  <b>KY5</b></p>
	<p><b>SCREWDRIVER BITS</b>            No.6 Screwdriver Bit            No.8 and M4 Screwdriver Bit            No.10 and M5 Screwdriver Bit            M6 Armature Plate Screwdriver Bit            M8 Armature Plate Screwdriver Bit            Screwdriver Handles</p>	<p><b>VRBIT6</b>  <b>VRBIT8</b>  <b>VRBIT10</b>  <b>VRBIT/M6/AP</b>  <b>VRBIT/M8/AP</b>  <b>HAND</b></p>
	<p><b>VANDAL RESISTANT MACHINE SCREWS</b>            M4 x 8mm            M4 x 12mm            M4 x 20mm            M5 x 6mm            M5 x 8mm            M5 x 12mm            M5 x 16mm            M5 x 20mm</p>	<p><b>S/STEEL</b> - Self Colour  <b>MSM4X8</b>  <b>MSM4X12</b>  <b>MSM4X20</b>  <b>MSM5X6</b>  <b>MSM5X8</b>  <b>MSM5X12</b>  <b>MSM5X16</b>  <b>MSM5X20</b></p>
	<p><b>VANDAL RESISTANT WOOD SCREWS</b>            No.6 x 1.00"            No.6 x 1.25"            No.6 x 1.50"            No.8 x 1.00"            No.8 x 1.25"            No.8 x 1.50"            No.10 x 1.25"            No.10 x 1.50"</p>	<p><b>BZP</b> - Zinc Plated  <b>BRASS</b> - Self Colour</p> <p><b>WS6X1BZP</b>  <b>WS6X1.25BZP</b>  <b>WS6X1.5BZP</b>  <b>WS8X1BZP</b>  <b>WS8X1.25BZP</b>  <b>WS8X1.5BZP</b>  <b>WS10X1.25BZP</b>  <b>WS10X1.5BZP</b></p> <p><b>WS6X1BR</b>  <b>WS6X1.25BR</b>  <b>WS6X1.5BR</b>  <b>WS8X1BR</b>  <b>WS8X1.25BR</b>  <b>WS8X1.5BR</b>  <b>WS10X1.25BR</b>  <b>WS10X1.5BR</b></p>
	<p><b>ARMATURE PLATE SECURING SCREWS</b>            M6 x 35mm stainless steel armature plate securing screw            M8 x 35mm stainless steel armature plate securing screw</p>	<p><b>MSM6X35</b>  <b>MSM8X35</b></p>
<p><b>NOTES:</b>            1. All screwdriver bits will interchange with one handle.            2. There is a minimum order of 100 for all screws (except armature plate securing screws which are supplied in batches of 10 off)            3. Special sized screws are available upon application.            4. All prices are ex.works. Carriage will be subject to weight / delivery method.</p>		

**SURVEILLANCE**

ALL CAMERA HOUSINGS ARE SUITABLE FOR LOBBIES, HALLS, LIFTS & STAIRWELL TYPE APPLICATIONS

**CODE**



**CORNER CAMERA HOUSING**

**FSM1900**

**DIMENSIONS:** 430mm x 302mm o/all  
**MATERIAL:** Chassis - 1.2mm 316 Stainless Steel  
 Front Plate - 2.5mm 316 Stainless Steel  
 Bracket - 2.5mm 316 Stainless Steel  
 Screen - 6mm polycarbonate  
**FINISH:** Satin



**SMALL RECTANGULAR HOUSING**

**FSM2100**

**DIMENSIONS:** 145mm (W) x 245mm (H) x 140mm (D) o/all  
**MATERIAL:** Cover - 2mm 316 Stainless Steel  
 Chassis - 1.2mm 316 Stainless Steel  
 Screen - 6mm polycarbonate  
 Speaker Cover - Stainless Steel gauze  
**FINISH:** Powder Coated Grey (RAL 7032 texture)



**LIFT SIDE CAMERA HOUSING**

**FSM1800**

**DIMENSIONS:** Length TBA (See Note 3 below) x 290mm (H) x 67mm (D)  
**MATERIAL:** Main Chassis - 1.5mm 316 Stainless Steel  
 Fixing Strips - 2.5mm 316 Stainless Steel  
 Screen - 3mm black 962 acrylic (infra red) - back  
 6mm polycarbonate - front  
**FINISH:** Satin

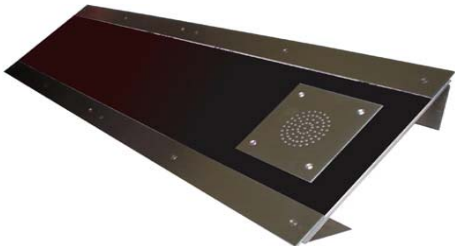

**LIFT SIDE CAMERA HOUSING c/w SPEAKER FACILITY**

**FSM1800S**

**DIMENSIONS:** Length TBA (See Note 3 below) x 290mm (H) x 67mm (D)  
**MATERIAL:** Main Chassis - 1.5mm 316 Stainless Steel  
 Fixing Strips - 2.5mm 316 Stainless Steel  
 Screen - 3mm black 962 acrylic (infra red) - back  
 6mm polycarbonate - front  
**FINISH:** Satin

**NOTES:**

1. Alternative RAL colours are available - please specify at order stage (could be subject to powder coating surcharge if non stock item).
2. All mild steel components are pre-treated to inhibit corrosion prior to being painted.
3. The maximum length of the Lift Side Camera Housings is 1250mm - please specify required length at time of order. For lengths in excess of 1250mm - price upon application.
4. All prices are ex.works. Carriage will be subject to weight / delivery method.





**ACCESS CONTROL POSTS**



**STANDARD PEDESTAL**

**DIMENSIONS:** Up to 1500mm high (please specify)  
**MATERIAL:** Post - 75mm dia 304 Stainless Steel  
 Floor Plate - 5mm 304 Stainless Steel  
 Main Body - 2.5mm 304 Stainless Steel  
**EQUIPMENT:** Provision only for Access Control Equipment (to be specified)  
**FINISH:** Satin

**ACP/STD**



**SQUARE PEDESTAL**

**DIMENSIONS:** Up to 1500mm high (please specify)  
**MATERIAL:** Main Body - 150mm SQ. 3mm 304 Stainless Steel  
 Floor Plate - 5mm 304 Stainless Steel  
**EQUIPMENT:** Provision only for Access Control Equipment (to be specified)  
**FINISH:** Satin

**ACP/SQ**



**ROUND PEDESTAL**







**DIMENSIONS:** Up to 1500mm high (please specify)  
**MATERIAL:** Main Body - 204mm Dia 2mm 304 Stainless Steel  
 Floor Plate - 5mm 304 Stainless Steel  
**EQUIPMENT:** Provision only for Access Control Equipment (to be specified)  
**FINISH:** Satin

**ACP/ROUND**

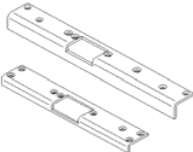
**NOTES:**

1. All Access Control Posts will be provided with cable access through base.
2. Equipment specified may be either from the FSM Security Product range or to your own specification. If the equipment is to your own specification, detailed drawings or the actual equipment would need to be provided in order for us to supply the correct fixings.
3. The floor plates in each case would be to suit M10 fixings (not supplied) unless specified otherwise.
4. In the case of the Standard Pedestal, the main body would be supplied as a Heavy Duty, Surface Mounted Housing with Rainhood (please refer to Illustration of Panel format on Page 1) unless specified otherwise.
5. All prices are ex.works. Carriage will be subject to weight / delivery method.

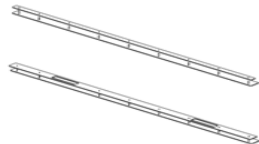

<b>DOOR ACCESSORIES</b>		<u><b>CODE</b></u>
	<p><b>LOCK RELEASE FACE PLATES</b></p> <p><b>MATERIAL:</b> 3mm 304 Stainless Steel</p> <p><b>FINISH:</b> Satin</p> <p><b>FIXING:</b> 4 No. M5 x 8mm Machine screws and 4 No. No.10 x 1.5" Woodscrews included</p> <p><b>LOCK RELEASE:</b> To suit Assa 650/13 Lock Release</p> <p style="text-align: right;">To suit Assa 650/16 Lock Release</p>	<p><b>LR/FP/13</b> <b>LR/FP/16</b></p>
	<p><b>D' HANDLE</b></p> <p><b>DIMENSIONS:</b> 305mm x 75mm</p> <p><b>MATERIAL:</b> 25mm Dia Stainless Steel (Satin finish)</p> <p><b>FIXING HOLES:</b> M8</p>	<p><b>DEE</b></p>
	<p><b>PUSH PLATES</b></p> <p><b>DIMENSIONS:</b> 350mm x 50mm</p> <p><b>MATERIAL:</b> Up to 1.5mm Stainless Steel (Satin finish)</p> <p><b>FIXING HOLES:</b> 4.5mm Dia to suit No.8 Wood Screws (see Page 5)</p>	<p><b>PP</b></p>
	<p><b>KICK PLATES</b></p> <p><b>DIMENSIONS:</b> 1000mm (Maximum width) x 150mm (Maximum height)</p> <p><b>MATERIAL:</b> Up to 1.5mm Stainless Steel (Satin finish)</p> <p><b>FIXING HOLES:</b> 4.5mm Dia to suit No.8 Wood Screws (see Page 5)</p>	<p><b>KP</b></p>
	<p><b>TEE BAR / LOCK PROTECTION PLATE (PLAIN)</b></p> <p><b>DIMENSIONS:</b> 2200mm (Maximum height) x 50mm wide x 44mm deep</p> <p><b>MATERIAL:</b> 3.0mm Stainless Steel (Satin finish)</p> <p><b>FIXING HOLES:</b> 4.5mm Dia to suit No.8 Wood Screws (see Page 5)</p> <p><b>TEE BAR / LOCK PROTECTION PLATE WITH LOCK CUT-OUTS</b></p>	<p><b>TP</b> <b>TM</b></p>
	<p><b>DOOR EDGE / LOCK PROTECTION CLAMP PLATES (PLAIN)</b></p> <p><b>DIMENSIONS:</b> 70mm front plate + 50mm back plate x 2200mm (Max height)</p> <p><b>MATERIAL:</b> 3.0mm Stainless Steel (Satin finish)</p> <p><b>FIXING HOLES:</b> 4.5mm Dia to suit No.8 Wood Screws (see Page 5)</p> <p><b>DOOR EDGE / LOCK PROTECTION CLAMP PLATES c/w MAGLOCK C/OUTS</b></p>	<p><b>GAPP</b> <b>GAPP</b></p>
	<p><b>DOWN LIGHTER - 150mm OR 220MM</b></p> <p><b>CANOPY:</b> 1.2mm Bright annealed 316 grade stainless steel</p> <p><b>CHASSIS:</b> 1.2mm Bright annealed 316 grade stainless steel</p> <p><b>LIGHTS:</b> KKL8 x 503 LED light strip bonded to the rear side of the chassis</p> <p><b>DIFFUSER:</b> 3mm Opal Polycarbonate or Plexiglass bonded to the canopy Canopy retained by 4 no. FSM - MSM4X12 security machine screws</p> <p><b>FIXINGS:</b> Chassis retained by either 4 No. FSM - WS8X1.5BZP security wood screws OR 4 No. FSM - MSM5X20 security machine screws c/w nuts &amp; washers (All the above are included in the fixing kit)</p>	<p><b>DL-150</b> <b>DL-220</b></p>
<p><b>NOTES:</b></p> <p>1. Vandal Resistant screws are not provided with the above (unless specifically mentioned), please refer to Page 5 of this price list.</p> <p>2. Where maximum dimensions are given, please state actual dimensions required upon placement of order.</p> <p>3. Special sizes available (prices upon request).</p> <p>4. All prices are ex.works. Carriage will be subject to weight / delivery method.</p>		 <p><b>FSM</b> MADE IN ENGLAND</p>

**DOOR ENTRY PANELS**

**TYPE 2 PANEL**

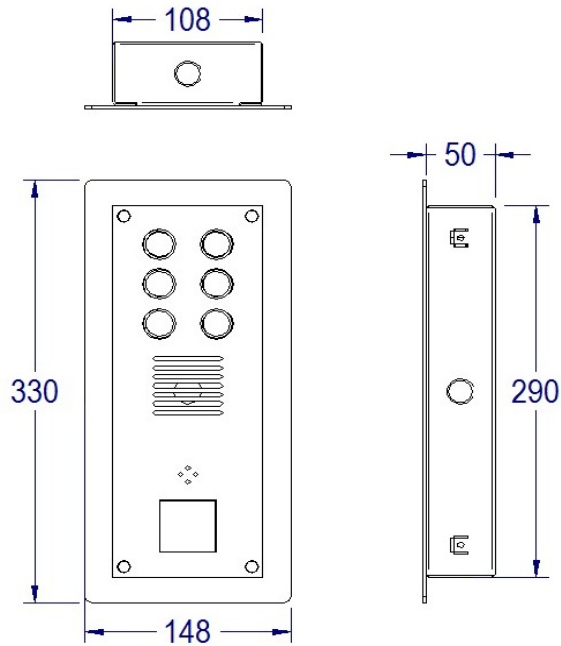

eg. T2-6/MB/P

**All panels can be manufactured to comply with your Disability Discrimination Act requirements**

(please contact us for further information)

**INCLUDING PROVISIONS FOR:-**

**AUDIO EQUIPMENT**

- 1 Way
- 2 Way
- 3 Way
- 4 Way
- 5 Way
- 6 Way
- 7 Way
- 8 Way
- 9 Way
- 10 Way

**AUDIO & PROXIMITY EQUIPMENT**

- 1 Way
- 2 Way
- 3 Way
- 4 Way
- 5 Way
- 6 Way

**AUDIO & VIDEO EQUIPMENT**

- 1 Way
- 2 Way
- 3 Way
- 4 Way
- 5 Way
- 6 Way

**AUDIO, PROXIMITY & VIDEO EQUIPMENT**

- 1 Way
- 2 Way

**Additional Costs**

- ◆ Engraving (per Character)
- ◆ Braille (per character)
- ◆ Yellow extended tactile pushbutton collar
- ◆ Standard Surface Mounted Models (Replace MB with ...)
- ◆ Rainhood Surface Mounted Models (Replace MB with ...)
- ◆ Fully Welded Heavy Duty Surface Mounted Models

**CODE**

- T2-1/MB
- T2-2/MB
- T2-3/MB
- T2-4/MB
- T2-5/MB
- T2-6/MB
- T2-7/MB
- T2-8/MB
- T2-9/MB
- T2-10/MB

- T2-1/MB/P
- T2-2/MB/P
- T2-3/MB/P
- T2-4/MB/P
- T2-5/MB/P
- T2-6/MB/P

- T2-1/MB/V
- T2-2/MB/V
- T2-3/MB/V
- T2-4/MB/V
- T2-5/MB/V
- T2-6/MB/V

- T2-1/MB/P/V
- T2-2/MB/P/V

- ENG
- BRAILLE
- /Y
- \_\_\_/SM
- \_\_\_/RH
- \_\_\_/SM/HD

**NOTES:**

1. All door entry panels are assuming that the speaker unit is no larger than 120mm x 80mm.
2. The cutting clearance for all entry panels should be the dimensions of the back box plus an additional 10mm all round.
3. MK5 mechanical push buttons are included in the above panel prices (see Page 3 for further details).
4. The standard engraving font is "Helvetica", the standard height is 7mm. Alternatives are available upon request.
5. M5 V/R machine screws are included in all door entry panels. Screwdrivers are at an additional cost (see Page 5)
6. All panels are also available in polished brass (overlap fascia panel design only), price upon request. S/Steel will be supplied as standard unless specified otherwise.
7. The hood on SM & RH models is manufactured from 1.5mm 316 s/steel & pop riveted in place. HD models are completely encased and fully welded from 2.5mm 316 s/steel.
8. We may require a sample camera with order (standard design is based on 40mm x 40mm board camera). These will be returned with completed order unless we are instructed otherwise.
9. All prices are ex.works. Carriage will be subject to weight / delivery method.



**DOOR ENTRY PANELS**

**TYPE 3 PANEL**

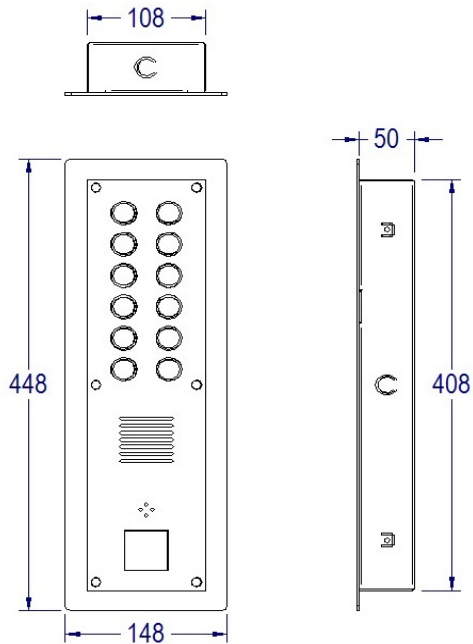

eg. T3-12/MB/P

**All panels can be manufactured to comply with your Disability Discrimination Act requirements**  
(please contact us for further information)

**INCLUDING PROVISIONS FOR:-**

**AUDIO EQUIPMENT**

- 11 Way
- 12 Way
- 13 Way
- 14 Way
- 15 Way
- 16 Way

**AUDIO & PROXIMITY EQUIPMENT**

- 7 Way
- 8 Way
- 9 Way
- 10 Way
- 11 Way
- 12 Way

**AUDIO & VIDEO EQUIPMENT**

- 7 Way
- 8 Way
- 9 Way
- 10 Way
- 11 Way
- 12 Way

**AUDIO, PROXIMITY & VIDEO EQUIPMENT**

- 3 Way
- 4 Way
- 5 Way
- 6 Way
- 7 Way
- 8 Way

**Additional Costs**

- ◆ Engraving (per Character)
- ◆ Braille (per character)
- ◆ Yellow extended tactile pushbutton collar
- ◆ Standard Surface Mounted Models (Replace MB with ...)
- ◆ Rainhood Surface Mounted Models (Replace MB with ...)
- ◆ Fully Welded Heavy Duty Surface Mounted Models

**CODE**

- T3-11/MB
- T3-12/MB
- T3-13/MB
- T3-14/MB
- T3-15/MB
- T3-16/MB

- T3-7/MB/P
- T3-8/MB/P
- T3-9/MB/P
- T3-10/MB/P
- T3-11/MB/P
- T3-12/MB/P

- T3-7/MB/V
- T3-8/MB/V
- T3-9/MB/V
- T3-10/MB/V
- T3-11/MB/V
- T3-12/MB/V

- T3-3/MB/P/V
- T3-4/MB/P/V
- T3-5/MB/P/V
- T3-6/MB/P/V
- T3-7/MB/P/V
- T3-8/MB/P/V

- ENG
- BRaille
- /Y
- \_\_\_/SM
- \_\_\_/RH
- \_\_\_/SM/HD

**NOTES:**

1. All door entry panels are assuming that the speaker unit is no larger than 120mm x 80mm.
2. The cutting clearance for all entry panels should be the dimensions of the back box plus an additional 10mm all round.
3. MK5 mechanical push buttons are included in the above panel prices (see Page 3 for further details).
4. The standard engraving font is "Helvetica", the standard height is 7mm. Alternatives are available upon request.
5. M5 V/R machine screws are included in all door entry panels. Screwdrivers are at an additional cost (see Page 5)
6. All panels are also available in polished brass (overlap fascia panel design only), price upon request. S/Steel will be supplied as standard unless specified otherwise.
7. The hood on SM & RH models is manufactured from 1.5mm 316 s/steel & pop riveted in place. HD models are completely encased and fully welded from 2.5mm 316 s/steel.
8. We may require a sample camera with order (standard design is based on 40mm x 40mm board camera). These will be returned with completed order unless we are instructed otherwise.
9. All prices are ex.works. Carriage will be subject to weight / delivery method.



**DOOR ENTRY PANELS**

**TYPE 4 PANEL**

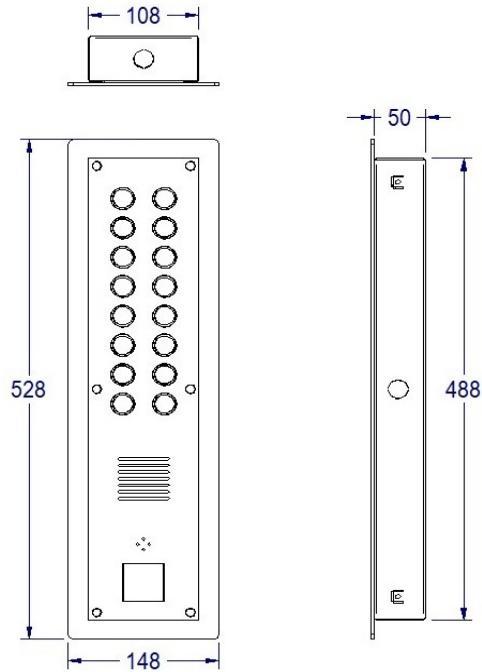

eg. T4-16/MB/P

**All panels can be manufactured to comply with your Disability Discrimination Act requirements**  
 (please contact us for further information)

**INCLUDING PROVISIONS FOR:-**

**AUDIO EQUIPMENT**

- 17 Way
- 18 Way
- 19 Way
- 20 Way

**AUDIO & PROXIMITY EQUIPMENT**

- 13 Way
- 14 Way
- 15 Way
- 16 Way

**AUDIO & VIDEO EQUIPMENT**

- 13 Way
- 14 Way
- 15 Way
- 16 Way

**AUDIO, PROXIMITY & VIDEO EQUIPMENT**

- 9 Way
- 10 Way
- 11 Way
- 12 Way

**CODE**

- T4-17/MB
- T4-18/MB
- T4-19/MB
- T4-20/MB

- T4-13/MB/P
- T4-14/MB/P
- T4-15/MB/P
- T4-16/MB/P

- T4-13/MB/V
- T4-14/MB/V
- T4-15/MB/V
- T4-16/MB/V

- T4-9/MB/P/V
- T4-10/MB/P/V
- T4-11/MB/P/V
- T4-12/MB/P/V

**Additional Costs**

- ◆ Engraving (per Character)
- ◆ Braille (per character)
- ◆ Yellow extended tactile pushbutton collar
- ◆ Standard Surface Mounted Models (Replace MB with ...)
- ◆ Rainhood Surface Mounted Models (Replace MB with ...)
- ◆ Fully Welded Heavy Duty Surface Mounted Models

- ENG
- BRAILLE
- /Y
- \_\_\_/SM
- \_\_\_/RH
- \_\_\_/SM/HD

**NOTES:**

1. All door entry panels are assuming that the speaker unit is no larger than 120mm x 80mm.
2. The cutting clearance for all entry panels should be the dimensions of the back box plus an additional 10mm all round.
3. MK5 mechanical push buttons are included in the above panel prices (see Page 3 for further details).
4. The standard engraving font is "Helvetica", the standard height is 7mm. Alternatives are available upon request.
5. M5 V/R machine screws are included in all door entry panels. Screwdrivers are at an additional cost (see Page 5)
6. All panels are also available in polished brass (overlap fascia panel design only), price upon request. S/Steel will be supplied as standard unless specified otherwise.
7. The hood on SM & RH models is manufactured from 1.5mm 316 s/steel & pop riveted in place. HD models are completely encased and fully welded from 2.5mm 316 s/steel.
8. We may require a sample camera with order (standard design is based on 40mm x 40mm board camera). These will be returned with completed order unless we are instructed otherwise.
9. All prices are ex.works. Carriage will be subject to weight / delivery method.



**DOOR ENTRY PANELS**

**TYPE 5 PANEL**

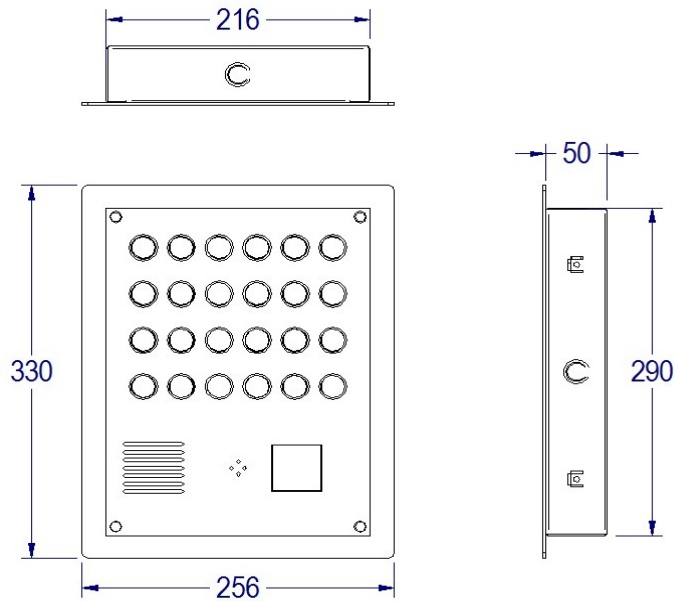

eg. T5-24/MB/P

**All panels can be manufactured to comply with your Disability Discrimination Act requirements**

(please contact us for further information)

**INCLUDING PROVISIONS FOR:-**

**AUDIO EQUIPMENT**

- 21 Way
- 22 Way
- 23 Way
- 24 Way

**AUDIO & PROXIMTY EQUIPMENT**

- 17 Way
- 18 Way
- 19 Way
- 20 Way
- 21 Way
- 22 Way
- 23 Way
- 24 Way

**AUDIO & VIDEO EQUIPMENT**

- 17 Way
- 18 Way
- 19 Way
- 20 Way
- 21 Way
- 22 Way
- 23 Way
- 24 Way

**AUDIO, PROXIMITY & VIDEO EQUIPMENT**

- 13 Way
- 14 Way
- 15 Way
- 16 Way
- 17 Way
- 18 Way
- 19 Way
- 20 Way

**Additional Costs**

As per Type 2,3 & 4 Door Entry Panels

**CODE**

- T5-21/MB
- T5-22/MB
- T5-23/MB
- T5-24/MB

- T5-17/MB/P
- T5-18/MB/P
- T5-19/MB/P
- T5-20/MB/P
- T5-21/MB/P
- T5-22/MB/P
- T5-23/MB/P
- T5-24/MB/P

- T5-17/MB/V
- T5-18/MB/V
- T5-19/MB/V
- T5-20/MB/V
- T5-21/MB/V
- T5-22/MB/V
- T5-23/MB/V
- T5-24/MB/V

- T5-13/MB/P/V
- T5-14/MB/P/V
- T5-15/MB/P/V
- T5-16/MB/P/V
- T5-17/MB/P/V
- T5-18/MB/P/V
- T5-19/MB/P/V
- T5-20/MB/P/V

**NOTES:**

1. All door entry panels are assuming that the speaker unit is no larger than 120mm x 80mm.
2. The cutting clearance for all entry panels should be the dimensions of the back box plus an additional 10mm all round.
3. MK5 mechanical push buttons are included in the above panel prices (see Page 3 for further details).
4. The standard engraving font is "Helvetica", the standard height is 7mm. Alternatives are available upon request.
5. M5 V/R machine screws are included in all door entry panels. Screwdrivers are at an additional cost (see Page 5)
6. All panels are also available in polished brass (overlap fascia panel design only), price upon request. S/Steel will be supplied as standard unless specified otherwise.
7. The hood on SM & RH models is manufactured from 1.5mm 316 s/steel & pop riveted in place. HD models are completely encased and fully welded from 2.5mm 316 s/steel.
8. We may require a sample camera with order (standard design is based on 40mm x 40mm board camera). These will be returned with completed order unless we are instructed otherwise.
9. All prices are ex.works. Carriage will be subject to weight / delivery method.



**DOOR ENTRY PANELS**

**TYPE 6 PANEL**

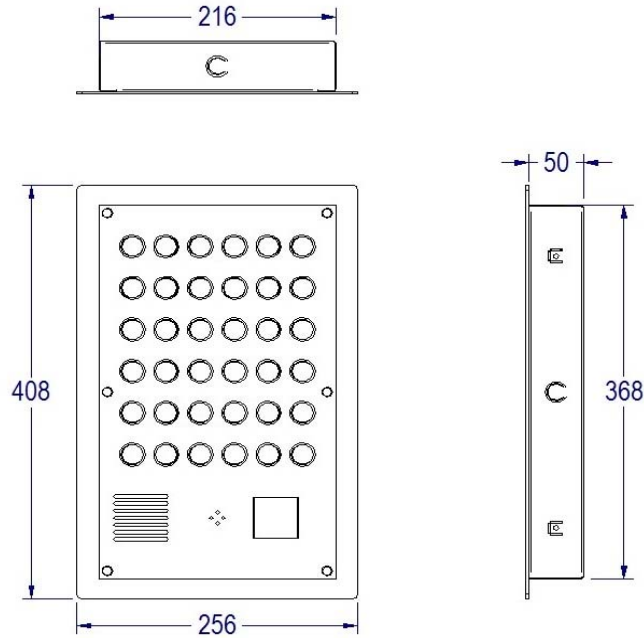

eg. T6-36/MB/P

**All panels can be manufactured to comply with your Disability Discrimination Act requirements**

(please contact us for further information)

**INCLUDING PROVISIONS FOR:-**

**AUDIO EQUIPMENT**

- 25 Way
- 26 Way
- 27 Way
- 28 Way
- 29 Way
- 30 Way
- 31 Way
- 32 Way
- 33 Way
- 34 Way
- 35 Way
- 36 Way

**AUDIO & PROXIMITY EQUIPMENT**

- 25 Way
- 26 Way
- 27 Way
- 28 Way
- 29 Way
- 30 Way
- 31 Way
- 32 Way
- 33 Way
- 34 Way
- 35 Way
- 36 Way

**CODE**

- T6-25/MB
- T6-26/MB
- T6-27/MB
- T6-28/MB
- T6-29/MB
- T6-30/MB
- T6-31/MB
- T6-32/MB
- T6-33/MB
- T6-34/MB
- T6-35/MB
- T6-36/MB

- T6-25/MB/P
- T6-26/MB/P
- T6-27/MB/P
- T6-28/MB/P
- T6-29/MB/P
- T6-30/MB/P
- T6-31/MB/P
- T6-32/MB/P
- T6-33/MB/P
- T6-34/MB/P
- T6-35/MB/P
- T6-36/MB/P

**NOTES:**

1. All door entry panels are assuming that the speaker unit is no larger than 120mm x 80mm.
2. The cutting clearance for all entry panels should be the dimensions of the back box plus an additional 10mm all round.
3. MK5 mechanical push buttons are included in the above panel prices (see Page 3 for further details).
4. The standard engraving font is "Helvetica", the standard height is 7mm. Alternatives are available upon request.
5. M5 V/R machine screws are included in all door entry panels. Screwdrivers are at an additional cost (see Page 5)
6. All panels are also available in polished brass (overlap fascia panel design only), price upon request. S/Steel will be supplied as standard unless specified otherwise.
7. The hood on SM & RH models is manufactured from 1.5mm 316 s/steel & pop riveted in place. HD models are completely encased and fully welded from 2.5mm 316 s/steel.
8. We may require a sample camera with order (standard design is based on 40mm x 40mm board camera). These will be returned with completed order unless we are instructed otherwise.
9. All prices are ex.works. Carriage will be subject to weight / delivery method.



**DOOR ENTRY PANELS**

**TYPE 6 PANEL (Continued)**

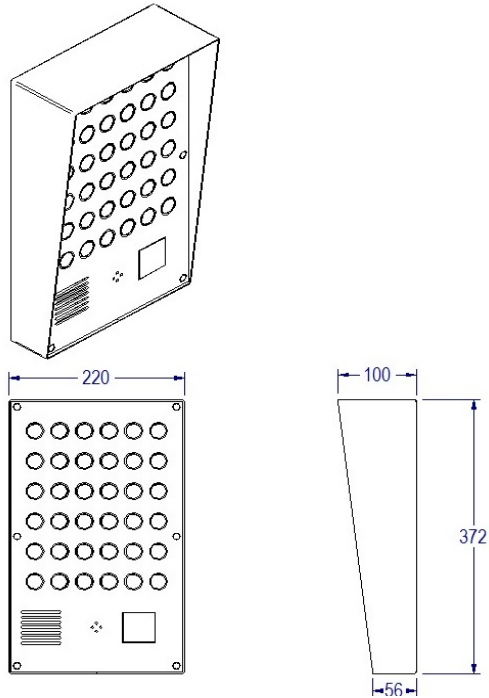

eg. T6-36/RH/P

**All panels can be manufactured to comply with your Disability Discrimination Act requirements**

(please contact us for further information)

**INCLUDING PROVISIONS FOR:-**

**AUDIO & VIDEO EQUIPMENT**

- 25 Way
- 26 Way
- 27 Way
- 28 Way
- 29 Way
- 30 Way
- 31 Way
- 32 Way

**AUDIO, PAC & VIDEO EQUIPMENT**

- 25 Way
- 26 Way
- 27 Way
- 28 Way
- 29 Way
- 30 Way
- 31 Way
- 32 Way

**CODE**

- T6-25/MB/V
- T6-26/MB/V
- T6-27/MB/V
- T6-28/MB/V
- T6-29/MB/V
- T6-30/MB/V
- T6-31/MB/V
- T6-32/MB/V

- T6-25/MB/P/V
- T6-26/MB/P/V
- T6-27/MB/P/V
- T6-28/MB/P/V
- T6-29/MB/P/V
- T6-30/MB/P/V
- T6-31/MB/P/V
- T6-32/MB/P/V

**Additional Costs**

- ◆ Engraving (per Character)
- ◆ Braille (per character)
- ◆ Yellow extended tactile pushbutton collar
- ◆ Standard Surface Mounted Models (Replace MB with ...)
- ◆ Rainhood Surface Mounted Models (Replace MB with ...)
- ◆ Fully Welded Heavy Duty Surface Mounted Models

ENG  
 BRAILLE  
 /Y  
 \_\_\_/SM  
 \_\_\_/RH  
 \_\_\_/SM/HD

**NOTES:**

1. All door entry panels are assuming that the speaker unit is no larger than 120mm x 80mm.
2. The cutting clearance for all entry panels should be the dimensions of the back box plus an additional 10mm all round.
3. MK5 mechanical push buttons are included in the above panel prices (see Page 3 for further details).
4. The standard engraving font is "Helvetica", the standard height is 7mm. Alternatives are available upon request.
5. M5 V/R machine screws are included in all door entry panels. Screwdrivers are at an additional cost (see Page 5)
6. All panels are also available in polished brass (overlap fascia panel design only), price upon request. S/Steel will be supplied as standard unless specified otherwise.
7. The hood on SM & RH models is manufactured from 1.5mm 316 s/steel & pop riveted in place. HD models are completely encased and fully welded from 2.5mm 316 s/steel.
8. We may require a sample camera with order (standard design is based on 40mm x 40mm board camera). These will be returned with completed order unless we are instructed otherwise.
9. All prices are ex.works. Carriage will be subject to weight / delivery method.





# FSM MANUFACTURING

## DOOR ENTRY / ACCESS CONTROL EQUIPMENT

### Material Specification

#### STAINLESS STEEL FASCIA & BEZEL:-

EN10088-2:1995/ASTM A240/316 =  
2.5MM 316 GRADE STAINLESS STEEL

#### BRASS FASCIA:-

BS.EN1652:1998/BS2870:1980/CZ108 =  
2.5MM MIRROR POLISHED BRASS

#### ALL BACK BOXES:-

1.2MM PRE-GALVANISED MILD STEEL SHEET

#### SURFACE SURROUNDS & RAINHOODS (S) STANDARD DUTY:-

1.2 - 1.6MM 316 GRADE STAINLESS STEEL (AS ABOVE)

#### SURFACE SURROUNDS & RAINHOODS (H) HEAVY DUTY:-

2.5MM 316 GRADE STAINLESS STEEL (AS ABOVE)

#### PUSHBUTTONS & SCREWS

MK6/2 DOUBLE POLE SWITCH PUSHBUTTONS INCLUDED WITHIN ALL PUSH TO EXIT HOUSINGS

MK5 STANDARD MECHANICAL PUSHBUTTONS INCLUDED WITHIN ALL ENTRY PANELS

ALL SCREWS USED WITHIN SM, RH & MB HOUSINGS WILL BE M5 VANDAL RESISTANT MACHINE SCREWS

ALL FASCIA PANELS WILL BE SUPPLIED WITH NO.10 VANDAL RESISTANT WOOD SCREWS & M5 MACHINE SCREWS

THE ABOVE WILL APPLY UNLESS OTHERWISE SPECIFIED

#### PUSHBUTTON OPTIONS

MK6/1 SINGLE POLE SWITCHED PUSHBUTTON

MK6/2 DOUBLE POLE SWITCHED PUSHBUTTON

#### MICROSWITCHES

AS USED IN THE MK6 RANGE PUSHBUTTON

ITW 19N-V4 IP67 SEALED SPDT (TWO SWITCHES ON MK6/2).

